



## ONE STAGE LIGHT OIL BURNERS

### ► PRESS GU SERIES

► PRESS G24 140 ÷ 280 kW

► PRESS GV 178 ÷ 356 kW

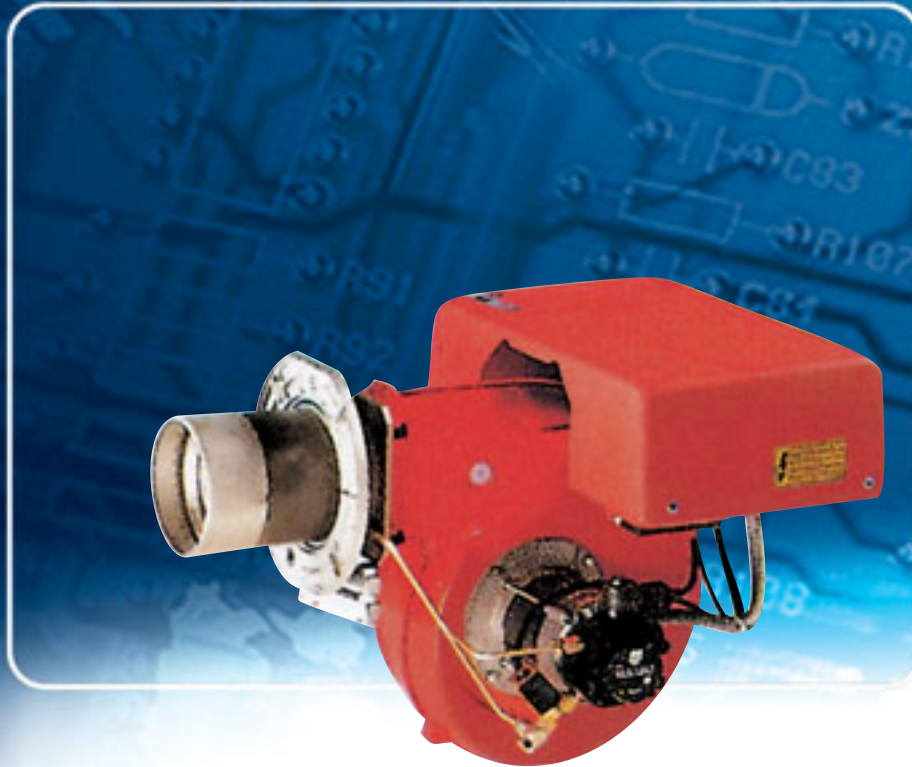

The PRESS G series of burners covers a firing range from 140 to 356 kW and they have been designed for use in civil installations of small dimensions or in industrial applications, like incinerators or drier kilns.

Operation is "one stage"; the burners are fitted with a microprocessor control panel which supplies indication of operation and diagnosis of fault cause. The combustion head, that can be set on the basis of required output, allows optimal performance ensuring good combustion and reducing fuel consumption.

The main feature of these burners is their reliability due to a simple and strong construction, which permits operation without particular maintenance intervention.

Simplified maintenance is achieved by the slide bar system, which allows easy access to all of the essential components of the combustion head. All electrical components are easily accessible only by dismantling a protection panel, thus guaranteeing a quick and simple intervention on components.



# TECHNICAL DATA

Model		▼ PRESS G24	▼ PRESS GV
<b>Burner operation mode</b>		One stage	
<b>Modulation ratio at max. output</b>		--	
Servomotor	type	--	
	run time	s	
Heat output	kW	140 - 280	178 - 356
	Mcal/h	120 - 241	153 - 306
	Kg/h	12 - 24	15 - 30
<b>Working temperature</b>	°C min./max.	0/40	
Net calorific value	kWh/kg	11,86	
	kcal/kg	10.200	
<b>Viscosity</b>	mm <sup>2</sup> /s (cSt)	4 ÷ 6 (at 20°C)	
Pump	type	AS 47	AN 67 A
	delivery	kg/h	31 (at 12 bar)
<b>Atomised pressure</b>	bar	12	
<b>Fuel temperature</b>	max. °C	50	
<b>Fuel pre-heater</b>		NO	
<b>Fan</b>	type	Centrifugal with forward curve blades	
<b>Air temperature</b>	max. °C	60	
<b>Electrical supply</b>	Ph/Hz/V	1/50/230~(±10%)	
<b>Auxiliary electrical supply</b>	Ph/Hz/V	1/50/230~(±10%)	
<b>Control box</b>	type	RMO	
<b>Total electrical power</b>	kW	0,4	0,48
<b>Auxiliary electrical power</b>	kW	0,15	0,23
<b>Heaters electrical power</b>	kW	--	
<b>Protection level</b>	IP	40	40
<b>Pump motor electrical power</b>	kW	--	
<b>Rated pump motor current</b>	A	--	
<b>Pump motor start up current</b>	A	--	
<b>Pump motor protection level</b>	IP	--	
<b>Fan motor electrical power</b>	kW	0,25	0,25
<b>Rated fan motor current</b>	A	2,1	2,1
<b>Fan motor start up current</b>	A	10	10
<b>Fan motor protection level</b>	IP	40	40
<b>Ignition trasformer</b>	type	--	
	V1 - V2	220V - 1x8 kV	200V - 1x8 kV
	I1 - I2	1,6A - 30 mA	1,8A - 30 mA
<b>Operation</b>		Intermittent (at least one stop every 24 h)	
<b>Sound pressure</b>	dBA	73	75,5
<b>Sound power</b>	W	--	--
<b>CO emission</b>	mg/kWh	< 40	
<b>Grade of smoke indicator</b>	N° Bacharach	< 1	
<b>C<sub>x</sub>H<sub>y</sub> emission</b>	mg/kWh	<10 (after the first 20 s.)	
<b>NO<sub>x</sub> emission</b>	mg/kWh	< 200	
<b>Directive</b>		73/23 - 89/336 - 98/37 - 92/42 EEC	
<b>Conforming to</b>		EN 267	
<b>Certification</b>		--	

## Reference conditions:

Temperature: 20°C

Pressure: 1000 mbar

Altitude: 100 m a.s.l.

Noise measured at a distance of 1 meter.

Since the Company is constantly engaged in the production improvement, the aesthetic and dimensional features, the technical data, the equipment and the accessories can be changed.

This document contains confidential and proprietary information of RIELLO S.p.A. Unless authorised, this information shall not be divulged, nor duplicated in whole or in part.



## FIRING RATES

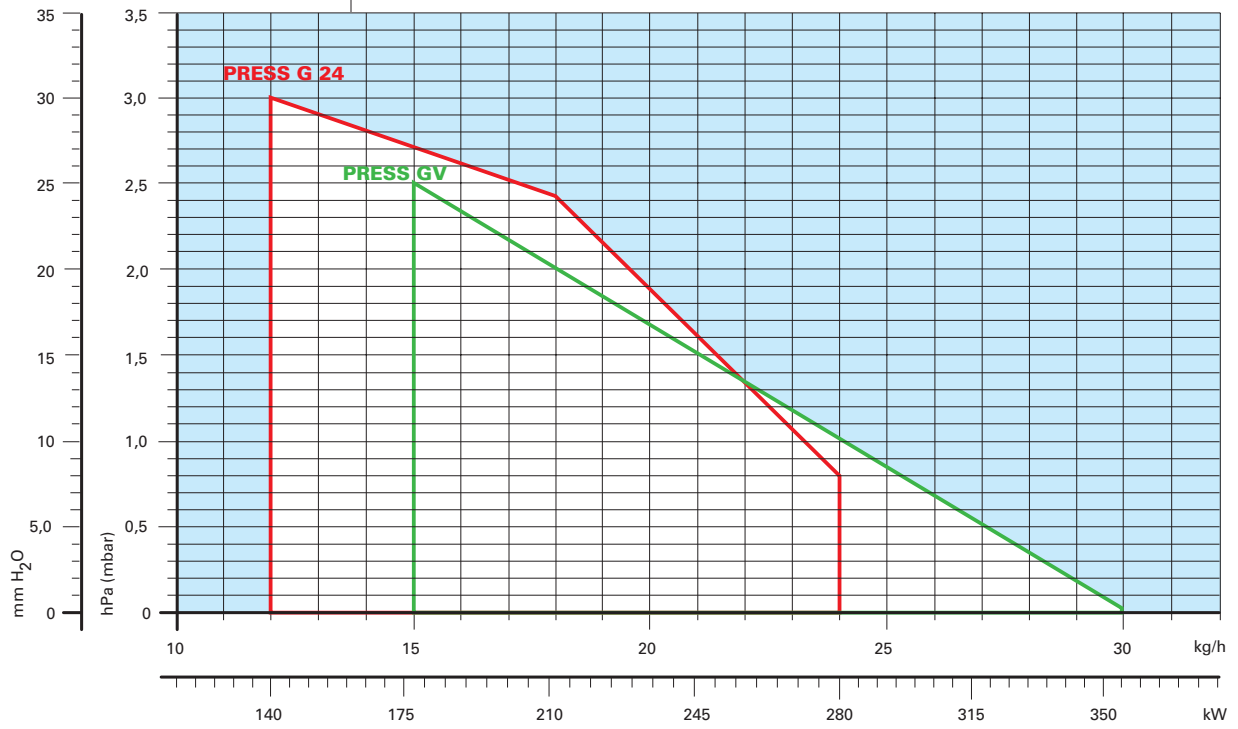

Useful working field for choosing the burner

**Test conditions conforming to EN 267:**

Temperature: 20°C  
Pressure: 1000 mbar  
Altitude: 100 m a.s.l.



# FUEL SUPPLY

## ► HYDRAULIC CIRCUIT

The burners are fitted with a self-priming pump and one (for PRESS GV) or two (for PRESS G24) delivery valves along the oil line from the pump to the nozzles. The pump does not need calibrating, as it is set in the factory at 12 bar; however, pressure level can be changed if necessary, by adjusting the regulator fitted on the pump. The delivery valves control the passage from starting to operating phase. For PRESS G24, at the start, after pre-purging phase, the first delivery valve opens and the fuel is sprayed out through the first nozzle, igniting when it comes into contact with the spark; then the second delivery valve opens and the fuel is sprayed out through both nozzles.

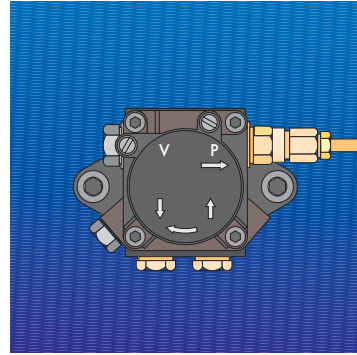

Example of self-priming pump of PRESS GV burners

### Hydraulic layout of PRESS G24 burner

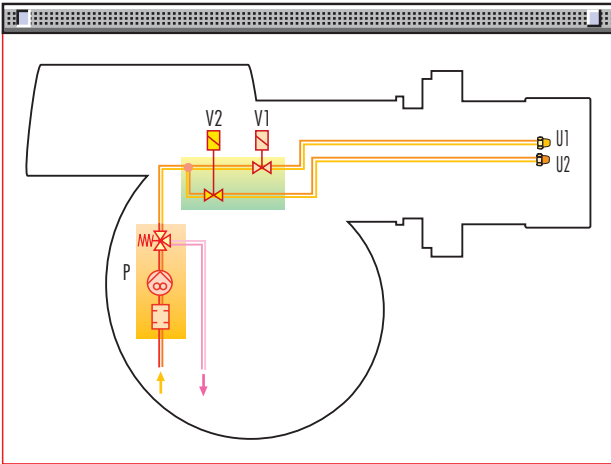

### Hydraulic layout of PRESS GV burner

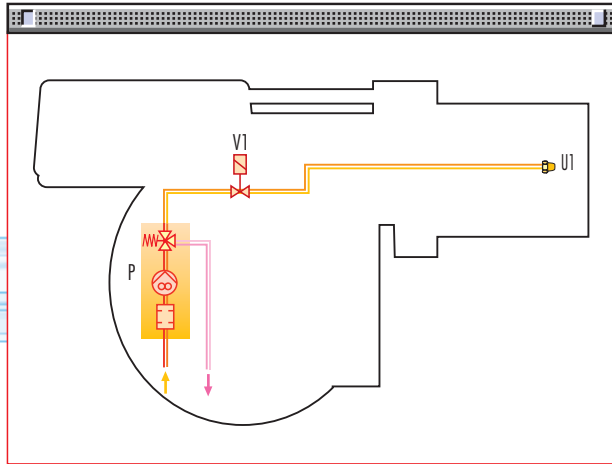

P	Pump with filter and pressure regulator
V1	1 <sup>st</sup> delivery valve
V2	2 <sup>nd</sup> delivery valve
U1	1 <sup>st</sup> nozzle
U2	2 <sup>nd</sup> nozzle



## ► DIMENSIONING OF THE FUEL SUPPLY LINES

The fuel feed must be completed with the safety devices required by the local norms.

The table shows the choice of piping diameter for the various burners, depending on the difference in height between the burner and the tank and their distance.

MAXIMUM EQUIVALENT LENGTH FOR THE PIPING L[m]		
Model	▼ PRESS G24 - GV	
Diameter piping	Ø 8 mm	Ø 10 mm
+H, -H (m)	L <sub>max</sub> (m)	L <sub>max</sub> (m)
+4,0	63	130
+3,0	55	115
+2,0	48	100
+1,5	44	92
+1,0	40	85
+0,5	36	78
0	32	70
-0,5	28	62
-1,0	24	55
-1,5	20	48
-2,0	16	40
-3,0	7	25
-4,0	-	10

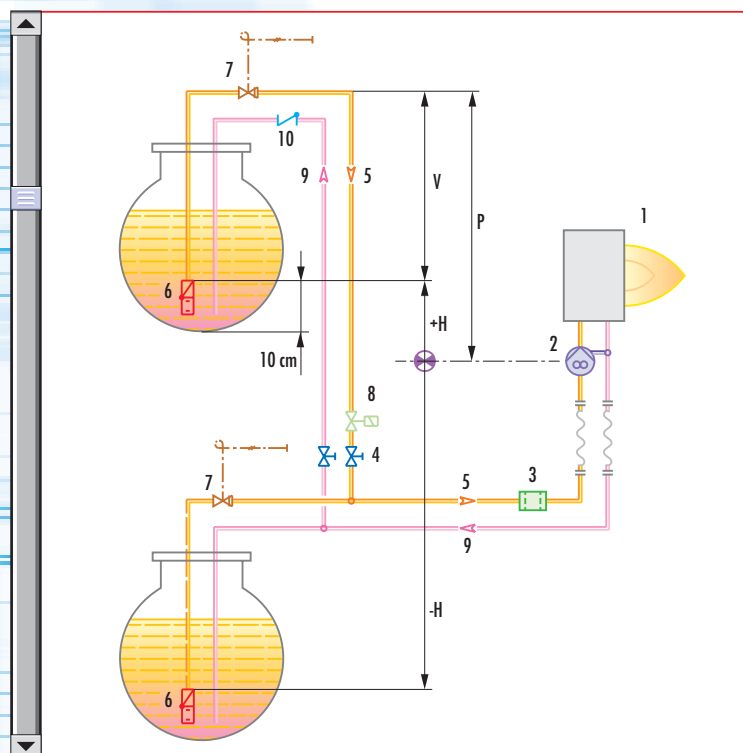

H	Difference in height pump-foot valve
Ø	Internal pipe diameter
P	Height 10 m (max)
V	Height 4 m
1	Burner
2	Burner pump
3	Filter
4	Manual shut off valve
5	Suction pipework
6	Bottom valve
7	Remote controlled rapid manual shut off valve (compulsory in Italy)
8	Type approved shut off solenoid valve (compulsory in Italy)
9	Return pipework
10	Check valve

► **note** *With ring distribution oil systems, the feasible drawings and dimensioning are the responsibility of specialised engineering studios, who must check compatibility with the requirements and features of each single installation.*



## VENTILATION

The ventilation circuit produces low noise levels with high performance pressure and air output, in spite of the compact dimensions.

The air damper is easy to set; when fitted, it makes no difference to air delivery.

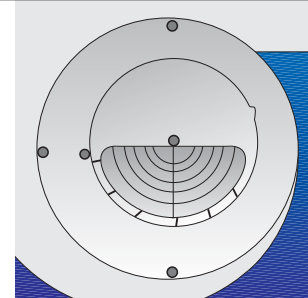

Example of fan air gate valve indexed selector of PRESS G24 burner



## COMBUSTION HEAD

For the PRESS G24 - GV series of burners a special kit for increasing combustion head length is available.

The choice of using it depends on the thickness of the front panel and the type of boiler.

Depending on the type of generator, check that the penetration of the head into the combustion chamber is correct.

The internal position of the combustion head can easily be adjusted to the maximum defined output by adjusting a screw fixed to the flange.

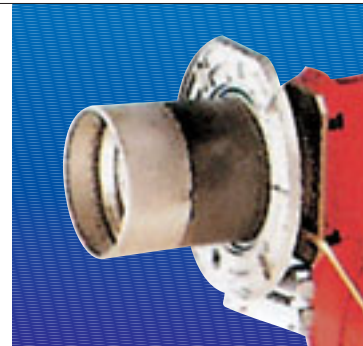

Example of a PRESS G24 burner combustion head

### Flame dimensions

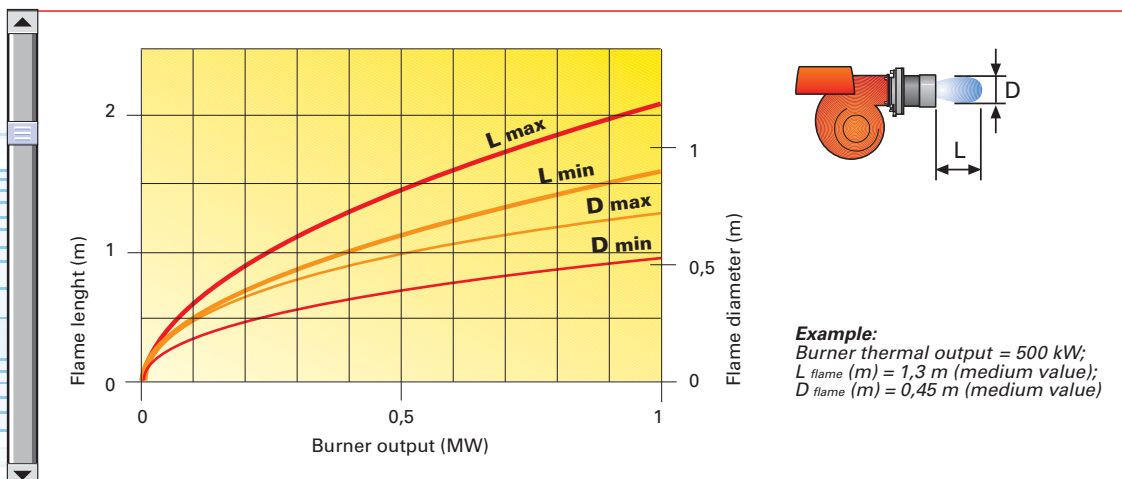

# ADJUSTMENT

## BURNER OPERATION MODE

### "One stage" operation

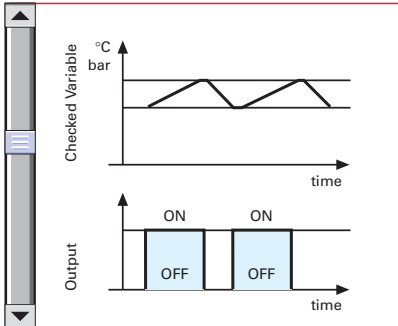

The burner of PRESS G24 - GV series is one stage working.

On "one stage" operation, the burner adjusts output to the requested level, by varying between on-off phases (see picture A).

Picture A

All PRESS GV series burners are fitted with a new microprocessor control panel for the supervision during intermittent operation.

For helping the commissioning and maintenance work, there are two main elements:



The lock-out reset button is the central **operating element** for resetting the burner control and for activating / deactivating the diagnostic functions.



The multi-color LED is the central **indication element** for visual diagnosis and interface diagnosis.

Both elements are located under the transparent cover of lock-out reset button, as showed below.

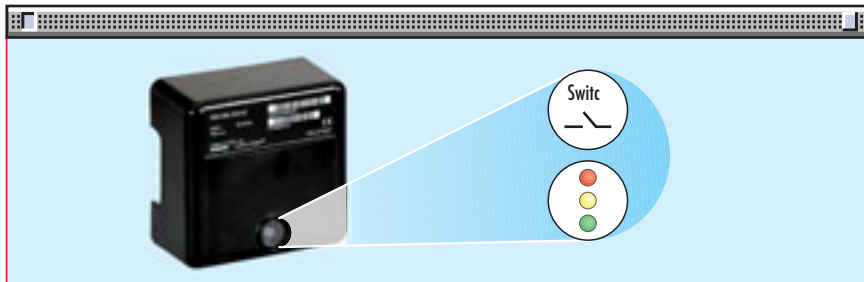

There are two diagnostic choices, for indication of operation and diagnosis of fault cause:

### - visual diagnosis :

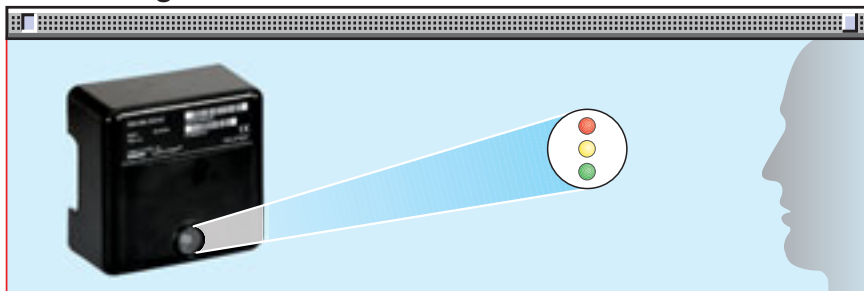

### - interface diagnosis :



by the interface adapter and a PC with dedicated software or by a predisposed flue gas analyzer (see paragraph accessories).





## Indication of operation :

In normal operation, the various statuses are indicated in the form of colour codes according to the table below.

The interface diagnosis (with adapter) can be activated by pressing the lock-out button for > 3 seconds.

Color code table	
Operation statuses	Color code table
Stand-by	○ ○ ○ ○ ○ ○ ○ ○
Pre-purging	☀ ☀ ☀ ☀ ☀ ☀ ☀ ☀
Ignition phase	☀ ○ ☀ ○ ☀ ○ ☀ ○
Flame OK	☀ ☀ ☀ ☀ ☀ ☀ ☀ ☀
Poor flame	☀ ○ ☀ ○ ☀ ○ ☀ ○
Undervoltage, built-in fuse	☀ ☀ ☀ ☀ ☀ ☀ ☀ ☀
Fault, alarm	☀ ☀ ☀ ☀ ☀ ☀ ☀ ☀
Extraneous light	☀ ☀ ☀ ☀ ☀ ☀ ☀ ☀

○ LED off

## Diagnosis of fault causes :

After lock-out has occurred, the red signal lamp is steady on. In this status, the visual fault diagnosis according to the error code table can be activated by pressing the lock-out reset button for > 3 seconds. The interface diagnosis (with adapter) can be activated by pressing again the lock-out button for > 3 seconds.

The blinkers of red LED are a signal with this sequence :

(e.g. signal with n° 3 blinks – faulty air pressure monitor)

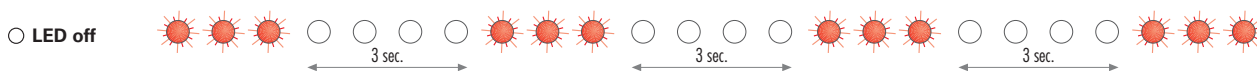

Error code table	
Possible cause of fault	Blink code
No establishment of flame at the end of safety time : - faulty or soiled fuel valves - faulty or soiled flame detector - poor adjustment of burner, no fuel - faulty ignition equipment	☀ ☀
Faulty air pressure monitor	☀ ☀ ☀
Extraneous light or simulation of flame on burner start up	☀ ☀ ☀ ☀
Loss of flame during operation : - faulty or soiled fuel valves - faulty or soiled flame detector - poor adjustment of burner	☀ ☀ ☀ ☀ ☀ ☀ ☀ ☀
Wiring error or internal fault	☀ ☀ ☀ ☀ ☀ ☀ ☀ ☀ ☀ ☀

## START UP CYCLE

### PRESS G24

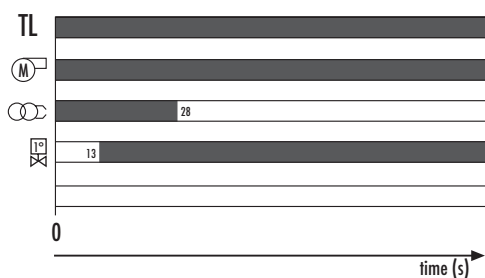

- 0s The burner begins the firing cycle; The motor starts: pre-purge phase; Ignition electrode sparks.
- 13s Delivery valve opens.
- 28s The spark goes out; Start up cycle is concluded.

### PRESS GV

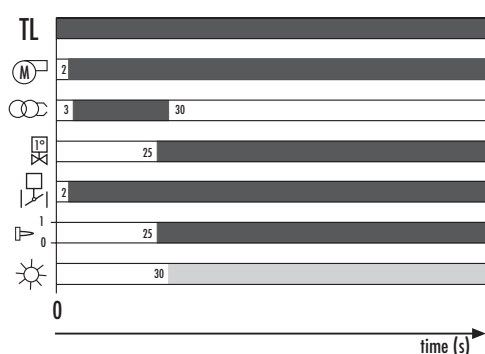

- 0s The burner begins the firing cycle.
- 2s The motor starts: pre-purge phase.
- 3s Ignition electrode sparks.
- 25s Delivery valve opens.
- 30s The spark goes out; start up cycle is concluded.



## WIRING DIAGRAMS

Electrical connections must be made by qualified and skilled personnel, according to the local norms.



### "ONE STAGE" OPERATION

#### PRESS G24

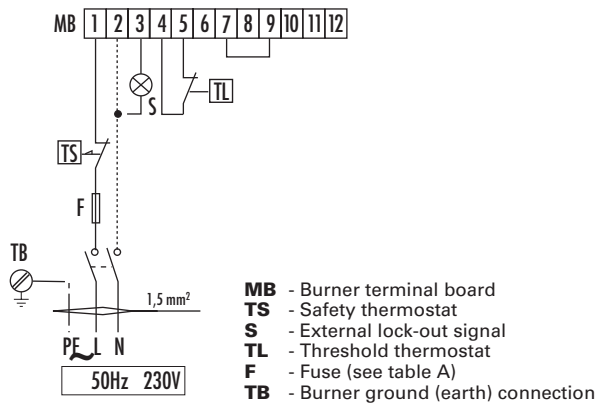

#### PRESS GV

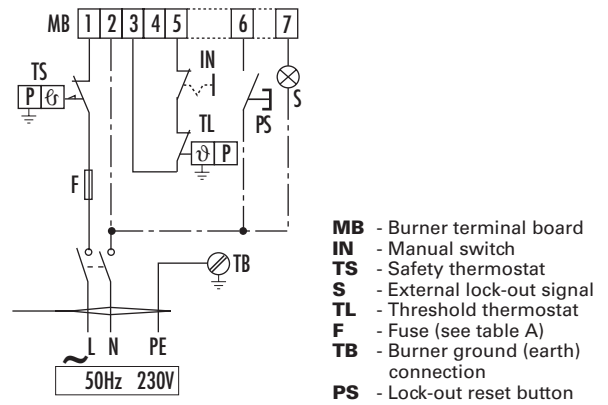

The following table shows the supply lead sections and the type of fuse to be used.

Model	▼ PRESS G24	▼ PRESS GV
	230V	230V
F A	T6	T6
L mm <sup>2</sup>	1,5	1,5

Table A

## EMISSIONS

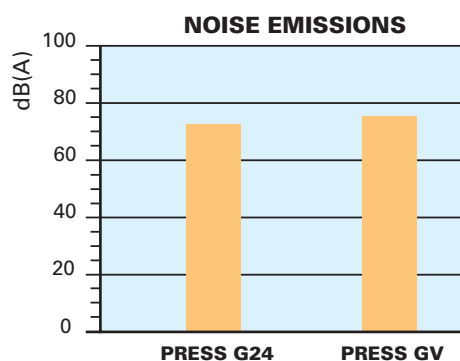
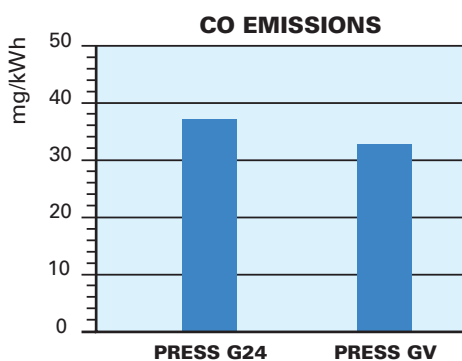
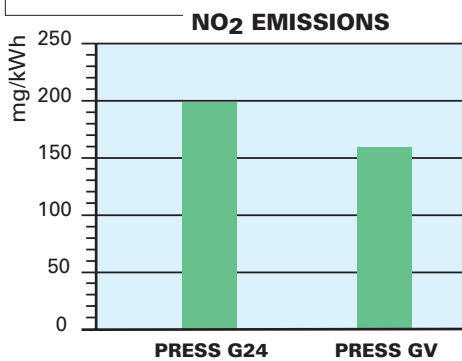

The emission data has been measured in the various models at maximum output, according to EN 267 standard.

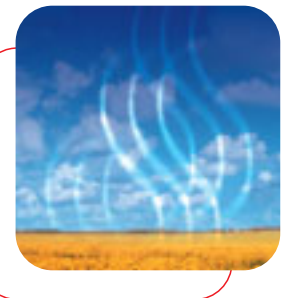



## OVERALL DIMENSIONS (mm)



### BURNER

PRESS G24

PRESS GV

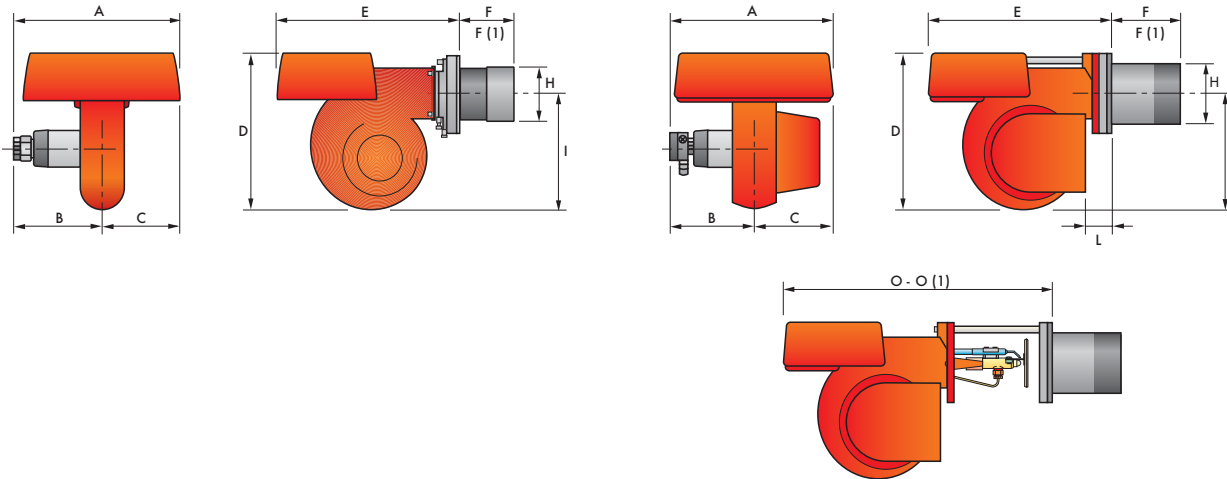

Model	A	B	C	D	E	F - F (1)	H	I	L	O - O (1)
► PRESS G24	425	222	203	397	485	118 - 253	125	290	-	- - -
► PRESS GV	439	234	205	397	473	185 - 320	140	292	59	690 - 825

(1) Length with extended combustion head.

### BURNER - BOILER MOUNTING FLANGE

PRESS G24

PRESS GV

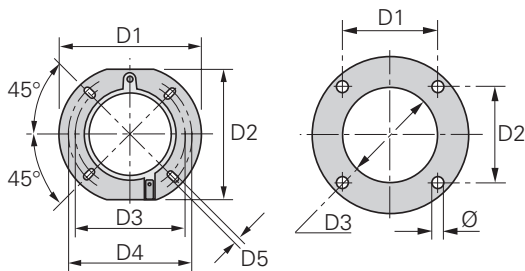

Model	D1	D2	D3	D4	D5	Ø
► PRESS G24	213	198	160	190	11	-
► PRESS GV	160	160	155	-	-	M10

### PACKAGING

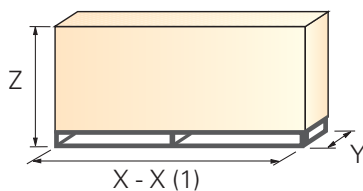

Model	X - X (1)	Y	Z	kg
► PRESS G24	650	535	450	33
► PRESS GV	680	535	450	33

(1) Length with extended combustion head.

## INSTALLATION DESCRIPTION



Installation, start up and maintenance must be carried out by qualified and skilled personnel. All operations must be performed in accordance with the technical handbook supplied with the burner.



### BURNER SETTING

#### PRESS G24

- ▶ After drilling the boilerplate, using the supplied gasket as a template, fix the flange of burner to the boiler.
- ▶ Dismantle the blast tube from the burner and install the nozzles, choosing these on the basis of the maximum boiler output and following the diagrams included in the burner instruction handbook.
- ▶ Check the position of the electrodes.
- ▶ Adjust the combustion head and refit the blast tube to the burner casing.
- ▶ Install the burner to the flange.

#### PRESS GV

- ▶ The PRESS GV model has slide bars, for easier installation and maintenance.
- ▶ After drilling the boilerplate, using the supplied gasket as a template, dismantle the blast tube from the burner and fix it to the boiler.
- ▶ Adjust the combustion head.
- ▶ Refit the burner casing to the slide bars.
- ▶ Install the nozzle, choosing this on the basis of the maximum boiler output and following the diagrams included in the burner instruction handbook.
- ▶ Check the position of the electrodes.
- ▶ Close the burner, sliding it up to the flange.

### HYDRAULIC, ELECTRICAL CONNECTIONS AND START UP

- ▶ The burners are supplied for connection to two pipes fuel supply system.
- ▶ Connect the ends of the flexible pipes to the suction and return pipework using the supplied nipples.
- ▶ Make the electrical connections to the burner following the wiring diagrams included in the instruction handbook.
- ▶ Prime the pump by turning the motor.
- ▶ On start up, check:
  - Pressure pump (to max. and min.)
  - Combustion quality, in terms of unburned substances and excess air.



## BURNER ACCESSORIES

### Nozzles

The nozzles must be ordered separately. The following table shows the features and codes on the basis of the maximum required fuel output.



Nozzles type 60°B			
Burner	Rated delivery kg/h (*)	GPH	Nozzle code
PRESS G24	6,3	1,50	3042107
PRESS G24	7,3	1,75	3042110
PRESS G24	8,5	2,00	3042126
PRESS G24	10,6	2,50	3042140
PRESS G24	12,7	3,00	3042158
PRESS G24	14,8	3,50	3042162
PRESS GV	17	4,00	3042172
PRESS GV	19,1	4,50	3042182
PRESS GV	21,2	5,00	3042192
PRESS GV	23,3	5,50	3042202
PRESS GV	25,5	6,00	3042212
PRESS GV	27,6	6,50	3042222
PRESS GV	29,7	7,00	3042232
PRESS GV	31,8	7,50	3042242

(\*) Nozzle rated delivery is referred to atomised pressure

### Extended head kit

“Standard head” burners can be transformed into “extended head” versions, by using the special kit. The kits available for the various burners, giving the original and the extended lengths, are listed below.

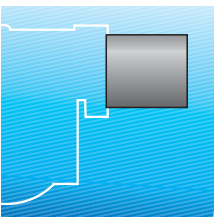

Extended head kit			
Burner	'Standard' head length (mm)	'Extended' head length (mm)	Kit code
PRESS G24	118	253	3010051
PRESS GV	185	320	3000580

### Spacer kit

If burner head penetration into the combustion chamber needs reducing, varying thickness spacers are available, as given in the following table:

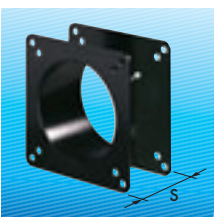

Spacer kit		
Burner	Spacer thickness S (mm)	Kit code
PRESS GV	142	3000755



### Sound proofing box

If noise emission needs reducing even further, sound-proofing box is available, as given in the following table:



Sound proofing box			
Burner	Box type	Average noise reduction [dB(A)] (*)	Box code
PRESS GV	C1/3	10	3010403

(\*) according to EN 15036-1 standard

### Degasing unit

With single pipe systems, you can find air in the oil sucked by the pump that comes from the oil itself due to negative pressure or to a faulty seal.

To solve this problem, we recommend fitting a degasing unit near the burner. Two versions are available with or without filter:



Degasing unit			
Burner	Filter	Filtering degree (µm)	Kit code
PRESS GV	with filter	50 - 75	3010055
PRESS GV	without filter	-	3010054

### PC interface kit

To connect the flame control panel to a personal computer for the transmission of operation, fault signals and detailed service information, an interface adapter with PC software are available.



PC interface kit	
Burner	Kit code
PRESS G24 - GV	3002719



## SPECIFICATION

A specific index guides your choice of burner from the various models available in the PRESS series. Below is a clear and detailed specification description of the product.

### DESIGNATION OF SERIES

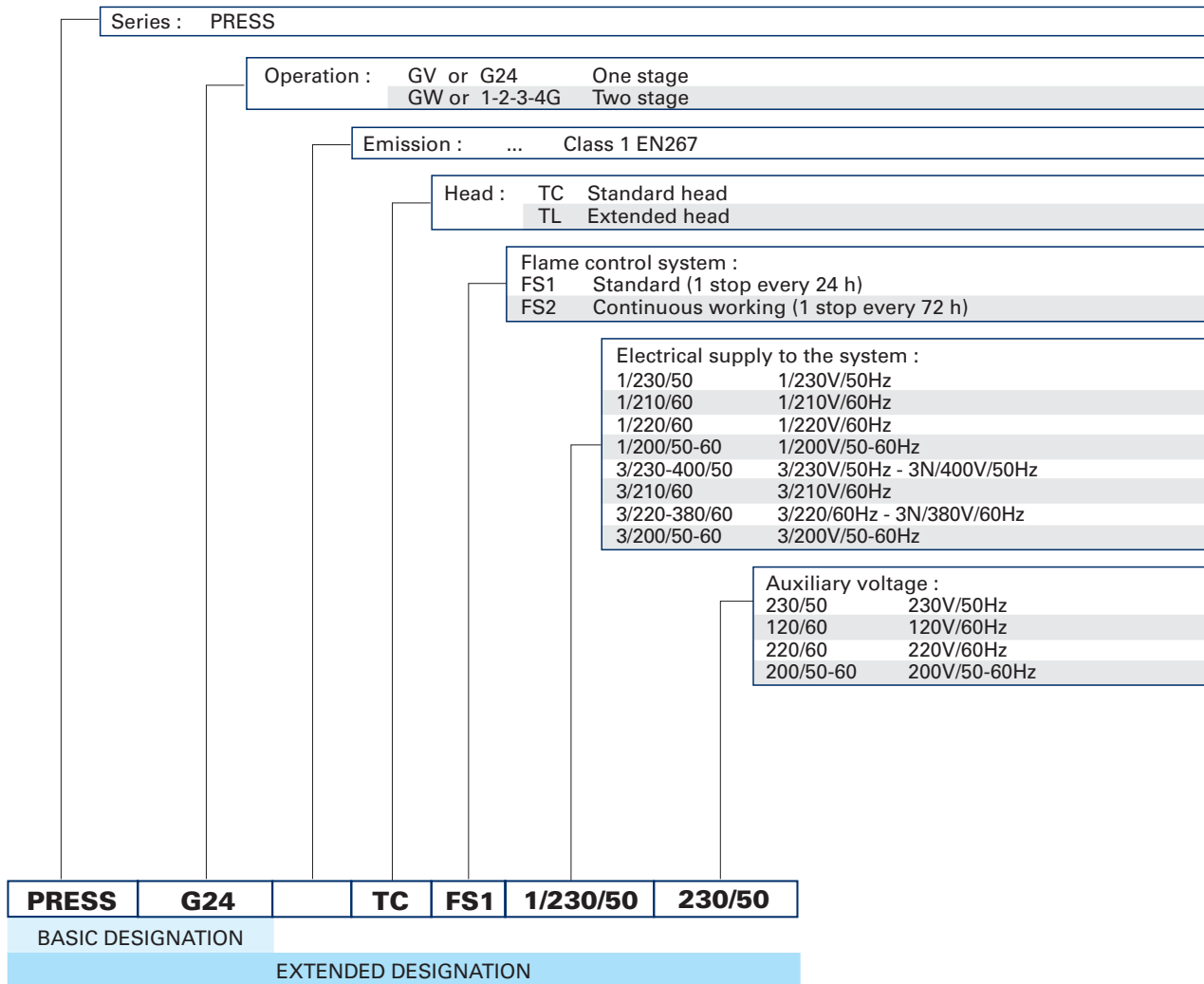

### AVAILABLE BURNER MODELS

PRESS G24	TC	FS1	1/230/50	230/50
PRESS G24	TC	FS1	1/220/60	220/60
PRESS GV	TC	FS1	1/200/50-60	200/50-60
PRESS GV	TC	FS1	1/230/50	230/50

Other versions are available on request.



## ▶ PRODUCT SPECIFICATION

### **Burner:**

Monoblock forced draught oil burner with one stage operation, fully automatic, made up of:

- Air suction circuit
- Fan with forward curve blades with high performance concerning pressure and air delivery
- Air damper for air setting
- Starting motor at 2850 rpm, single-phase, 230V, 50Hz
- Combustion head, that can be set on the basis of required output, fitted with:
  - stainless steel end cone, resistant to corrosion and high temperatures
  - ignition electrodes
  - flame stability disk
- Gears pump for high pressure fuel supply, fitted with:
  - filter
  - pressure regulator
  - connections for installing a pressure gauge and vacuumeter
  - internal by-pass for single pipe installation
- Oil valves on the output circuit
- Photocell for flame detection
- Microprocessor based flame control panel, with diagnostic functions
- Slide bars for easier installation and maintenance (for GV model)
- Protection filter against radio interference
- IP 44 electric protection level.

### **Conforming to:**

- 89/336/EEC directive (electromagnetic compatibility)
- 73/23/EEC directive (low voltage)
- 92/42/EEC directive (performance)
- 98/37/EEC directive (machinery)
- EN 267 (liquid fuel burners).

### **Standard equipment:**

- 2 flexible pipes for connection to the oil supply network
- 2 gaskets for the flexible pipes
- 2 nipples for connection to the pump
- 2 Pipe fittings (for GV model)
- 2 Pipe fittings gasket (for GV model)
- 1 burner flange (for G24 model)
- 4 screws for fixing the burner flange to the boiler
- 1 thermal screen
- Instruction handbook for installation, use and maintenance
- Spare parts catalogue.

### **Available accessories to be ordered separately:**

- Nozzles
- Extended head kit
- Spacer kit
- Sound-proofing box (for GV model)
- Degassing unit (for GV model)
- PC interface kit.



RIELLO S.p.A. - Via Ing. Pilade Riello, 5 - 37045 Legnago (VR) Italy  
Tel. ++39.0442630111 - Fax ++39.044221980

Internet: <http://www.rielloburners.com> - E-mail: [info@rielloburners.com](mailto:info@rielloburners.com)

Since the Company is constantly engaged in the production improvement, the aesthetic and dimensional features, the technical data, the equipment and the accessories can be changed.  
This document contains confidential and proprietary information of RIELLO S.p.A.  
Unless authorised, this information shall not be divulged, nor duplicated in whole or in part.

